

Deep learning

Convolutional Networks¹

Hamid Beigy

Sharif University of Technology

November 4, 2022



¹Some slides are taken from B. Raj's slides



1. Introduction
2. Example
3. Training the network with shared parameter
4. Convolution
5. Convolutional Neural networks
6. Convolutional neural network architectures
7. Case studies
8. Reading

Introduction



1. Consider a Perceptron with threshold activation function

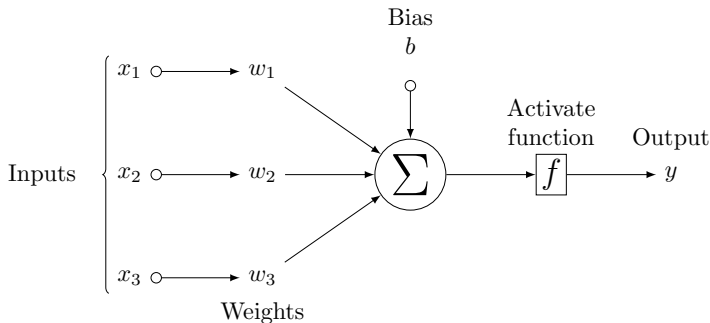

$$y = \begin{cases} 1 & \text{if } w^T x \geq b \\ 0 & \text{otherwise} \end{cases}$$

2. What do the weights tell us?
3. The Perceptron **fires** if the inner product between the weights and the inputs exceeds a threshold.

1. In Perceptron, we have

$$\mathbf{w}^T \mathbf{x} \geq b$$

$$\cos(\theta) \geq \frac{b}{\|\mathbf{x}\| \|\mathbf{w}\|}$$

$$\theta < \cos^{-1} \left(\frac{b}{\|\mathbf{x}\| \cdot \|\mathbf{w}\|} \right)$$

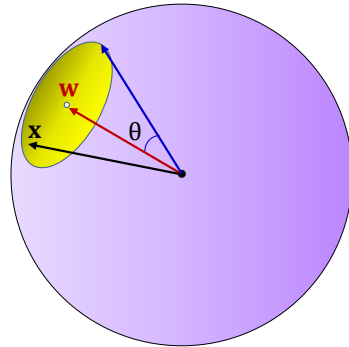

2. The Perceptron fires if the input vector is close enough to the weight vector.



1. If the correlation between the weight pattern and the inputs exceeds a threshold, **Perceptron fires**.
2. The Perceptron is a **correlation filter**.

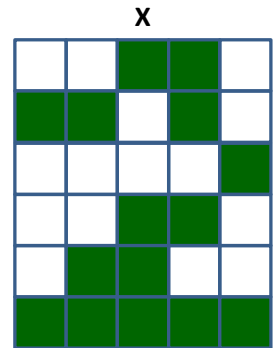
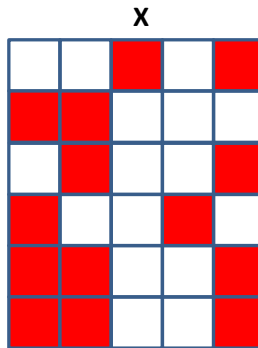
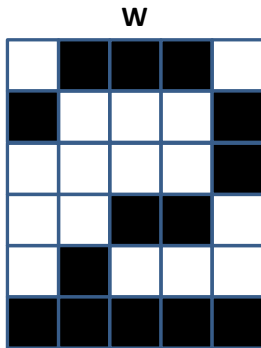

1. Consider a classification task in which, we want to classify digit images from non-digit images.

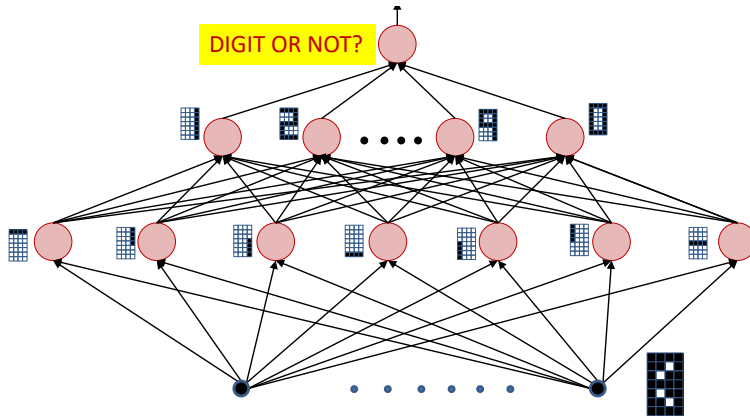

2. The network is a cascade of feature detectors
3. Higher level neurons compose complex templates from features represented by lower-level neurons.

Example

1. Does the following signal contain the word Hello?

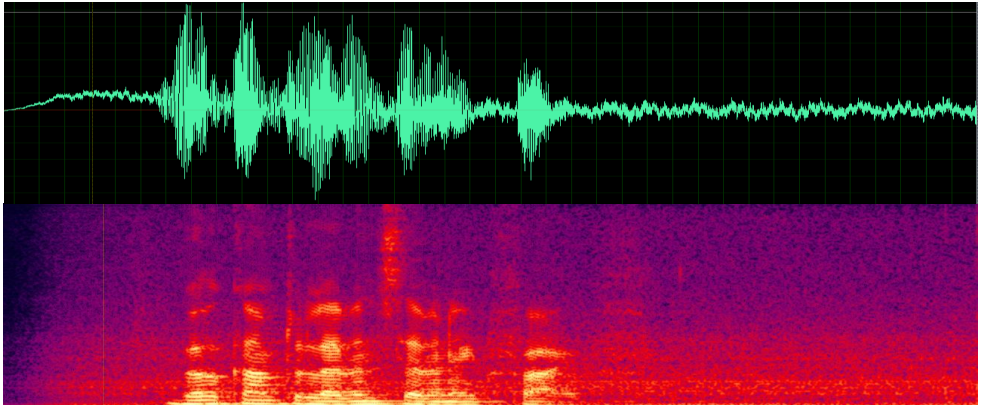

2. Can MLP be used to solve the above problem?

1. We can use a large network.

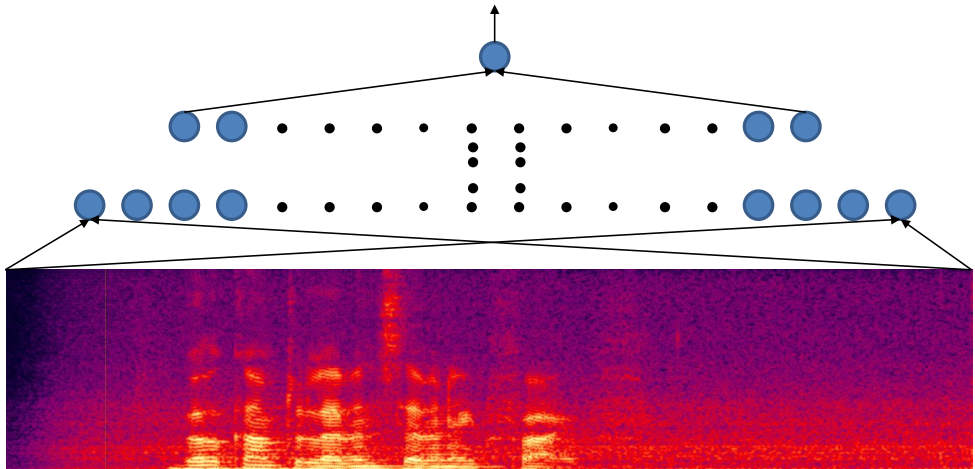

1. Network that finds a Hello in the top recording will not find it in the lower one
 - ▶ Unless trained with both
 - ▶ Will require a very large network and a large amount of training data to cover every case

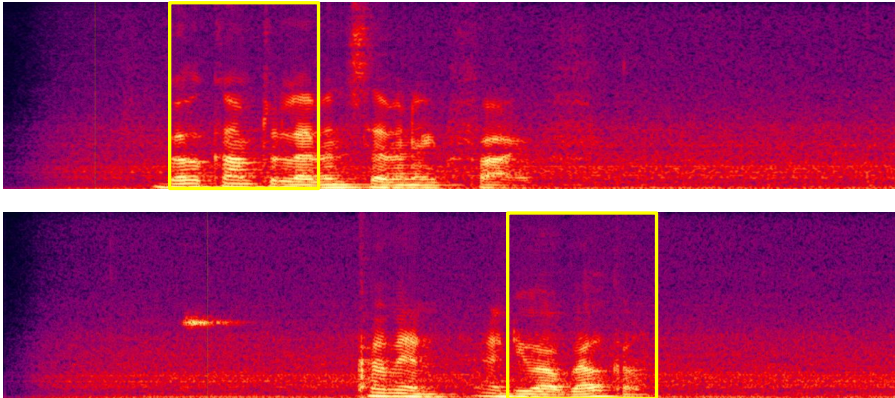

1. We need a simple network that **will fire** regardless of the location of **Hello** and **not fire** when there is **none**.

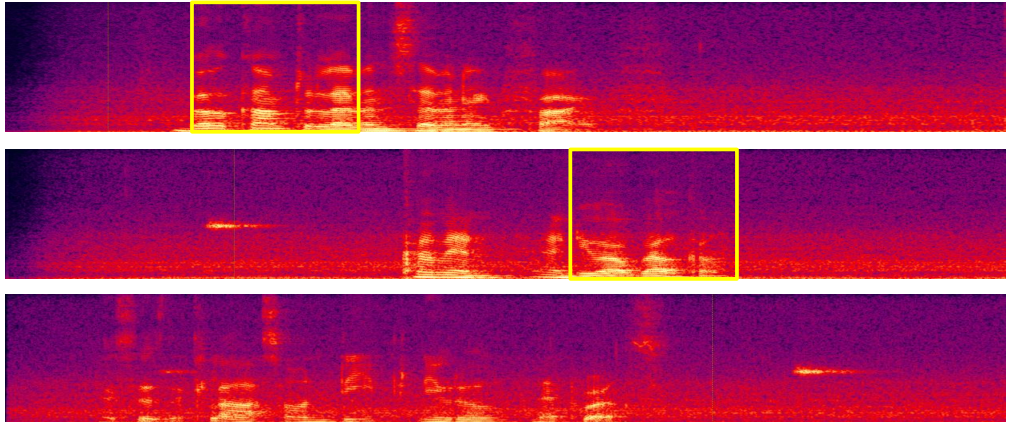

1. In many problems the location of a pattern is not important (Only the presence of the pattern).

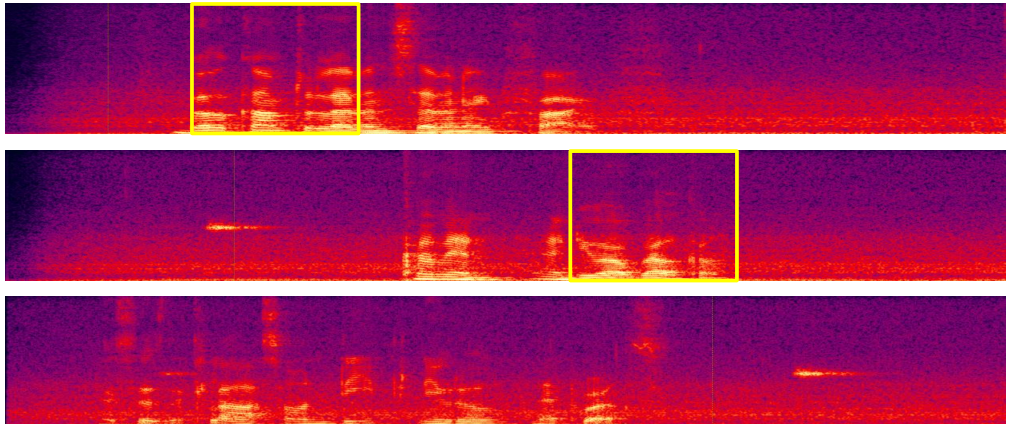

2. Conventional MLPs are sensitive to the location of the pattern.
3. Network must be shift invariant

1. Use a **sliding window** and scan for the target word.

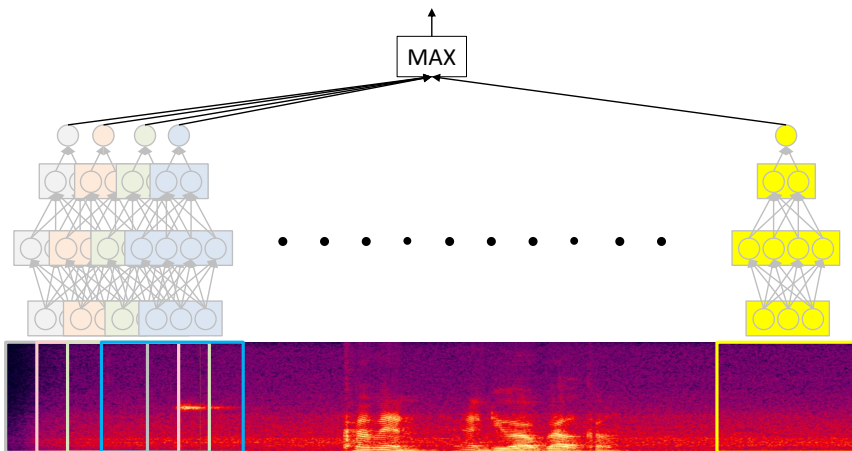

2. Does **Hello** occur in this recording?
 - ▶ We have classified many **windows** individually
 - ▶ **Hello** may have occurred in any of them.
3. Maximum of all the outputs (Equivalent of Boolean OR)

1. Use a **sliding window** and scan for the target word.

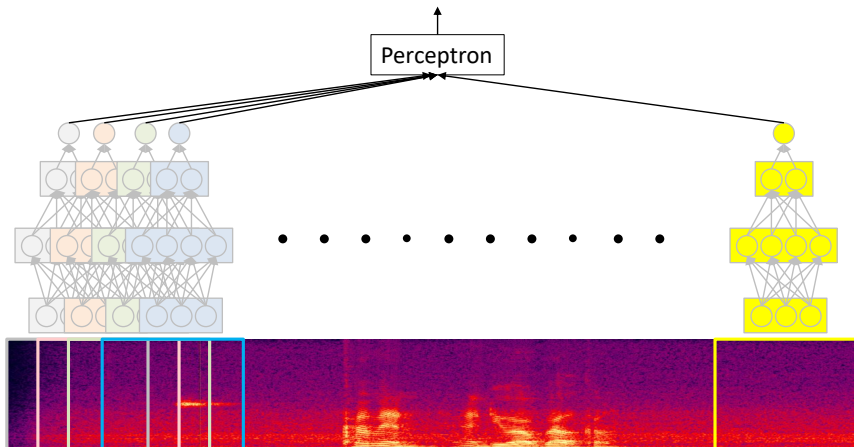

2. Does **Hello** occur in this recording?
3. Use a Perceptron to decide.

1. Use a **sliding window** and scan for the target word.

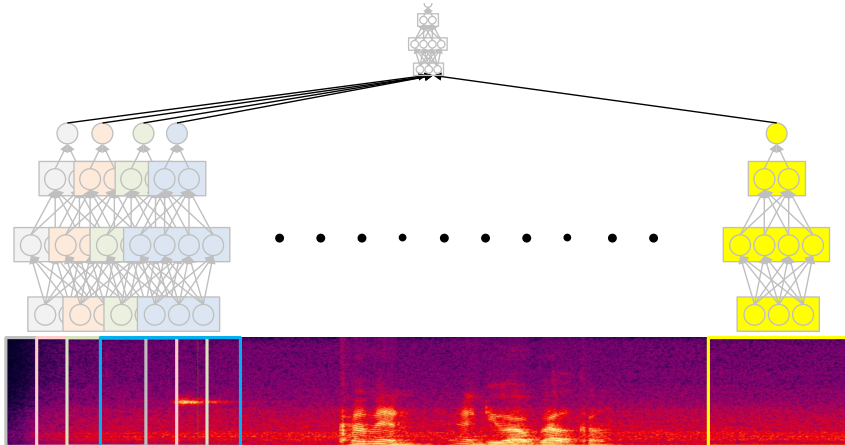

2. Does **Hello** occur in this recording?
3. Use a MLP to decide.

1. The entire operation can be viewed as one large network.

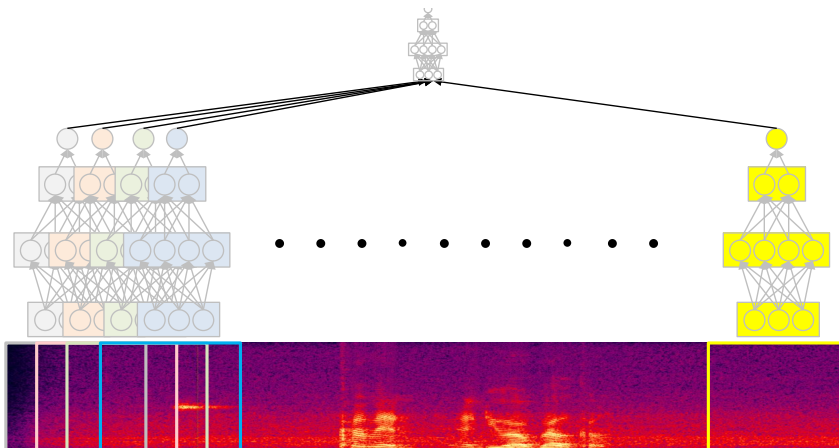

2. With many subnetworks, one per window
3. Restriction: All subnets are identical (*why?*)

1. What are the properties of this network?

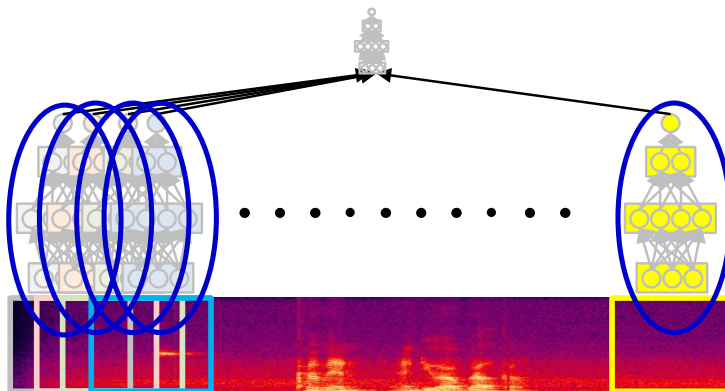

2. The sub-networks are shared parameter networks.
3. All lower-level subnets are identical (**Are all searching for the same pattern?**)
4. Any update of the parameters of one copy of the subnet must equally update all copies

1. What are the properties of this network?

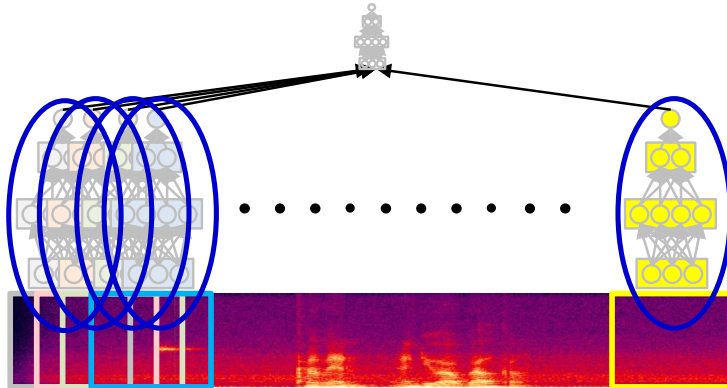

2. The network is sparse.
3. All sub-networks are used for local regions.



1. We have two strings s_1 and s_2 with lengths n_1 and n_2 , respectively.
2. Assume that $n_1 \gg n_2$.
3. Is s_2 a substring of s_1 ?
4. What is the solution?

Training the network with shared parameter



1. We use conventional back-propagation to learn the parameters.
2. By Providing many training examples, we use Gradient descent to minimize the cost function.
3. There are shared parameter networks and any update of the parameters of one copy of the subnet must equally update all copies.
4. Consider a simple network with the following parameter sharing $w_{ij} = w_{kl} = w_s$
5. We can calculate the gradient with respect to w_s .

$$\begin{aligned}\frac{\partial J(w)}{\partial w_s} &= \frac{\partial J(w)}{\partial w_{ij}} \frac{\partial w_{ij}}{\partial w_s} + \frac{\partial J(w)}{\partial w_{kl}} \frac{\partial w_{kl}}{\partial w_s} \\ &= \frac{\partial J(w)}{\partial w_{ij}} + \frac{\partial J(w)}{\partial w_{kl}}\end{aligned}$$

Convolution



1. The following operation is called **convolution**.

$$s(t) = \int_{-\infty}^{+\infty} x(\tau)w(t - \tau)d\tau$$

2. The convolution operation is typically denoted with an **asterisk(*)**.

$$s(t) = (x * w)(t) = \int_{-\infty}^{+\infty} x(\tau)w(t - \tau)d\tau$$

3. This operation has two steps: **flipping** and **shifting**
4. Then multiplication and integration.



1. If we now assume that x and w are defined only on integer t , we can define the discrete convolution:

$$s[n] = (x * w)[n] = \sum_{m=-\infty}^{\infty} x[m]w[n - m]$$

2. What is the relation of **convolution** and **cross-correlation**?



1. In practice, we often use convolutions over more than one axis at a time.

$$s[i, j] = (I * K)[i, j] = \sum_{m=-\infty}^{\infty} \sum_{n=-\infty}^{\infty} I[m, n]K[i - m, j - n]$$

2. The input is usually a multidimensional array of data.
3. The kernel is usually a multidimensional array of parameters that should be learned.
4. We assume that these functions are zero everywhere but the finite set of points for which we store the values.
5. We can implement the infinite summation as a summation over a finite number of array elements.

Convolution (example)



1	1	1	0	0
0	1	1	1	0
0	0	1	1	1
0	0	1	1	0
0	1	1	0	0

Image

4		

Convolved Feature

1	1	1	0	0
0	1	1	1	0
0	0	1	1	1
0	0	1	1	0
0	1	1	0	0

Image

4	3	

Convolved Feature

1	1	1	0	0
0	1	1	1	0
0	0	1	1	1
0	0	1	1	0
0	1	1	0	0

Image

4	3	4

Convolved Feature

1	1	1	0	0
0	1	1	1	0
0	0	1	1	1
0	0	1	1	0
0	1	1	0	0

Image

4	3	4
2		

Convolved Feature

1	1	1	0	0
0	1	1	1	0
0	0	1	1	1
0	0	1	1	0
0	1	1	0	0

Image

4	3	4
2	4	

Convolved Feature

1	1	1	0	0
0	1	1	1	0
0	0	1	1	1
0	0	1	1	0
0	1	1	0	0

Image

4	3	4
2	4	3

Convolved Feature

1	1	1	0	0
0	1	1	1	0
0	0	1	1	1
0	0	1	1	0
0	1	1	0	0

Image

4	3	4
2	4	3
2		

Convolved Feature

1	1	1	0	0
0	1	1	1	0
0	0	1	1	1
0	0	1	1	0
0	1	1	0	0

Image

4	3	4
2	4	3
2	3	

Convolved Feature

1	1	1	0	0
0	1	1	1	0
0	0	1	1	1
0	0	1	1	0
0	1	1	0	0

Image

4	3	4
2	4	3
2	3	4

Convolved Feature

Convolutional Neural networks



1. Convolutional neural network is a kind of feed-forward neural network that is able to extract features from data with convolution structures (Li et al. [2020](#)).
2. The architecture of CNN is inspired by visual perception.
3. A convolutional layer is a network layer that implements convolution.
4. A convolutional neural network is a feed-forward network in which at least one layer is convolution layer.
5. Convolutional neural networks have the following characteristics
 - ▶ Sparse & local interactions
 - ▶ Parameter sharing
 - ▶ Down-sampling dimensionality reduction
 - ▶ Equi-variant representations

1. Sparse vs dense connectivity

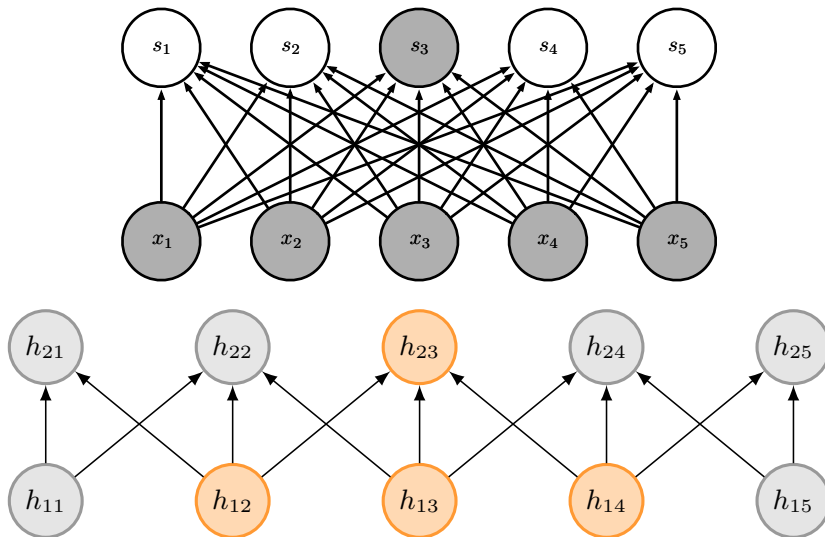



1. Sparse connectivity in multi-layers

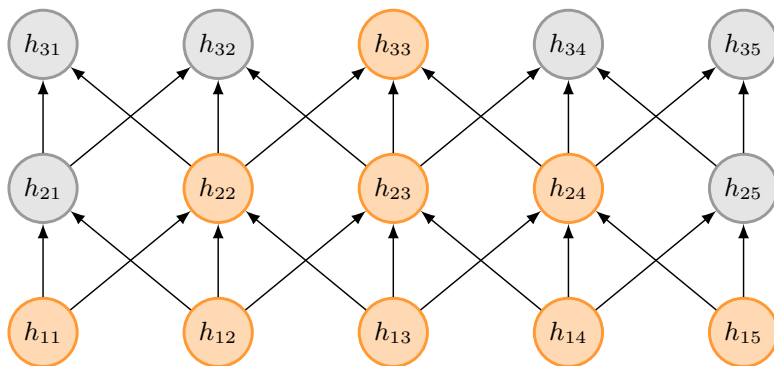

1. In CNNs each member of the kernel is used at every position of the input

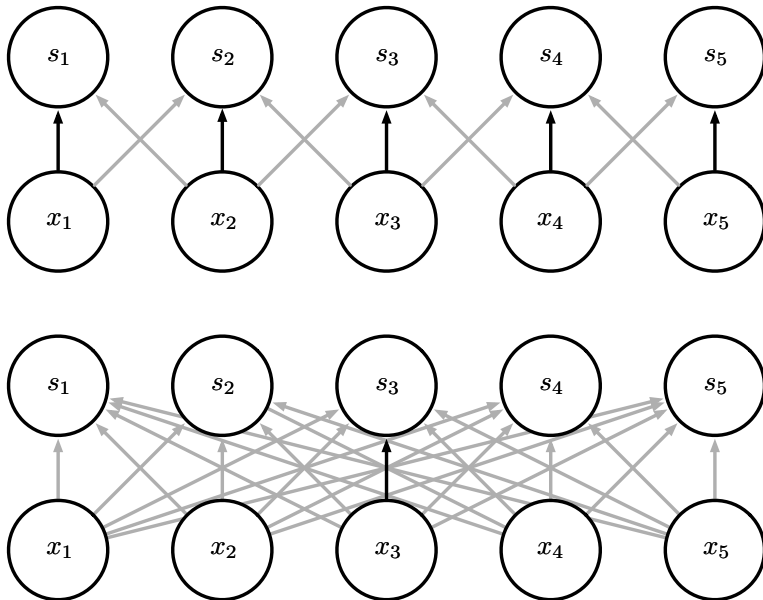



1. A function $f(\cdot)$ is equivariant to a function $g(\cdot)$ if $f(g(x)) = g(f(x))$.
2. A convolutional layer is equivariance to translation.
3. For example

$$g(x)[i] = g(x)[i - 1]$$

4. If we apply this transformation to x , then apply convolution, the result will be the same as if we applied convolution to x , then applied the transformation to the output. (Check it.)
5. If we move an object in the image, its representation will move the same amount in the output
6. Note that convolution is not equivariant to some other transformations, such as changes in the scale or rotation of an image.



1. The components of a typical convolutional neural network layer.

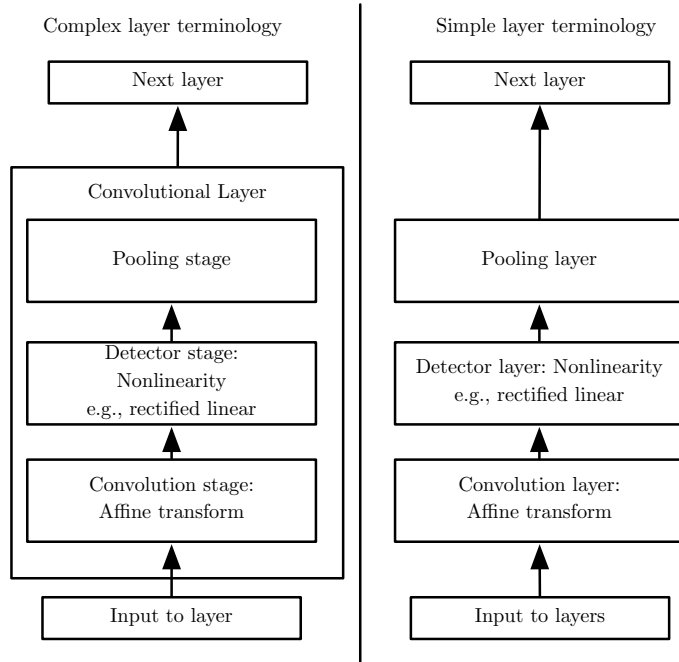



- To build a CNN model, four components are typically needed (Li et al. 2020).

Convolution The outputs of convolution can be called feature maps.

Padding Padding enlarges the input with zero value.

Stride For controlling the density of convolving, stride used.

Pooling As a result, Pooling (down-sampling) such as max pooling and average pooling obviates large number of features in feature map.

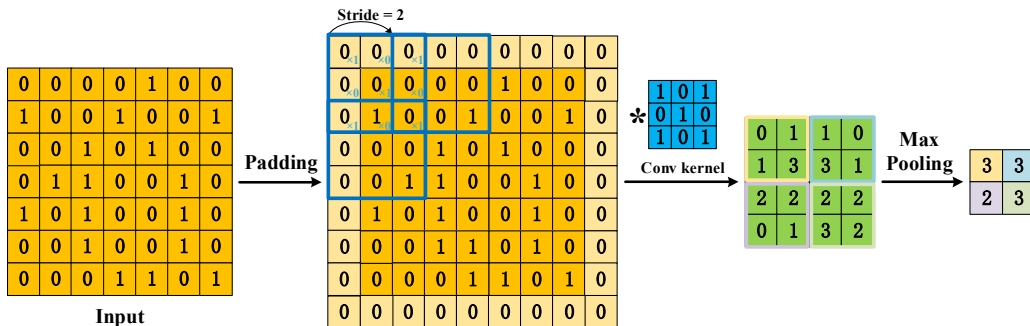

The convolutional stage is

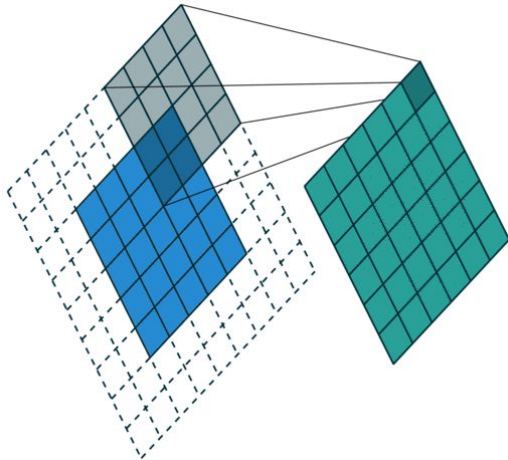

For convolution kernels to perceive larger area, dilated convolution used (Li et al. 2020).

- (a) A general 3×3 convolution kernel.
- (b) A 2-dilated 3×3 convolution kernel.
- (c) A 4-dilated 3×3 convolution kernel.



(a)

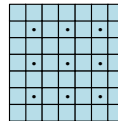

(b)

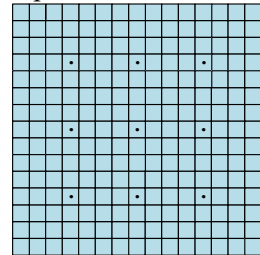

(c)

1. Now, we don't have just one filter in a convolutional layer, but multiple filters.
2. We call each output (matrix) a slice.

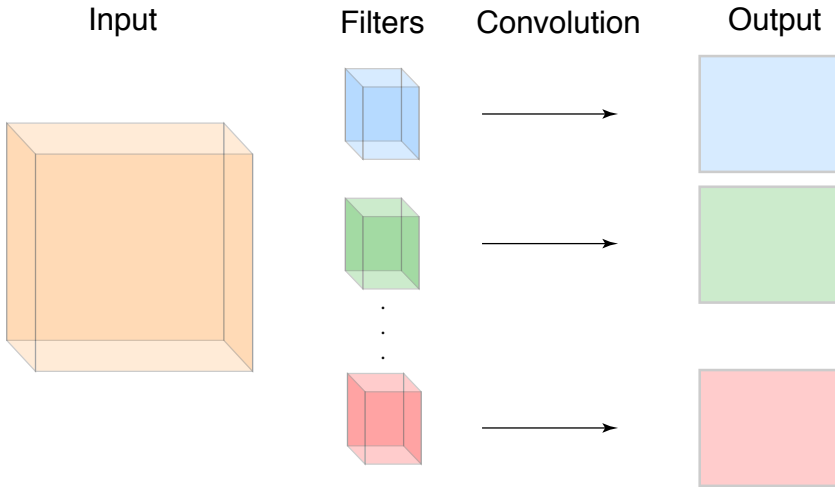

1. Multiple filters.

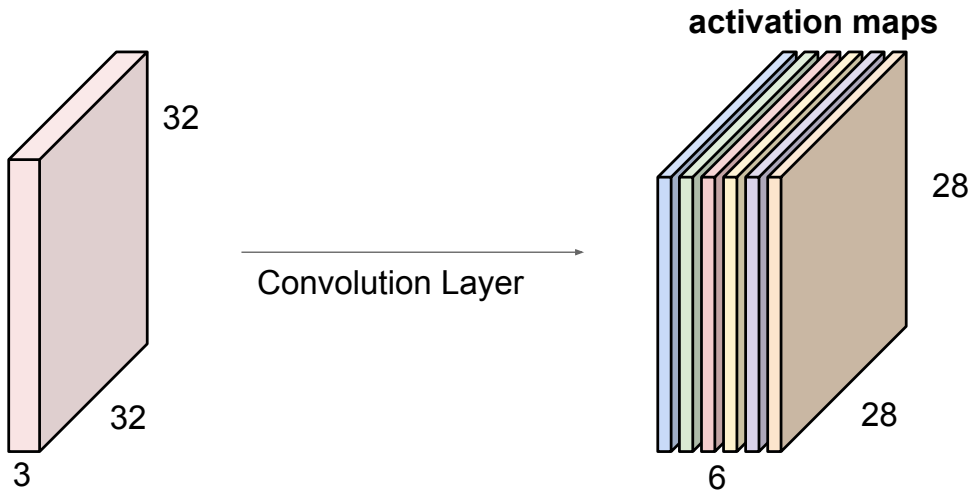



- Usually, we specify a variable `pad` which is the amount of zeros to pad on each border.

`pad = 0`

`pad = 1`

0	0	0	0	0
0				0
0				0
0				0
0	0	0	0	0

`pad = 2`

0	0	0	0	0	0	0
0	0	0	0	0	0	0
0	0				0	0
0	0				0	0
0	0				0	0
0	0	0	0	0	0	0
0	0	0	0	0	0	0



1. Another variable to control is the stride, which defines how much the filter moves in the convolution.

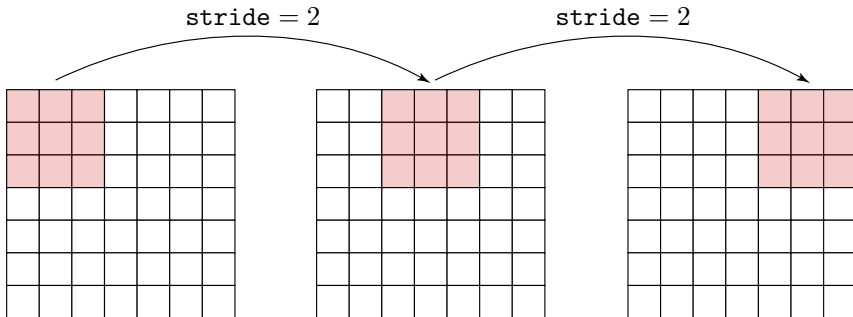

1. To handle irregular shapes, **deformable convolution** is used (Dai et al. 2017)

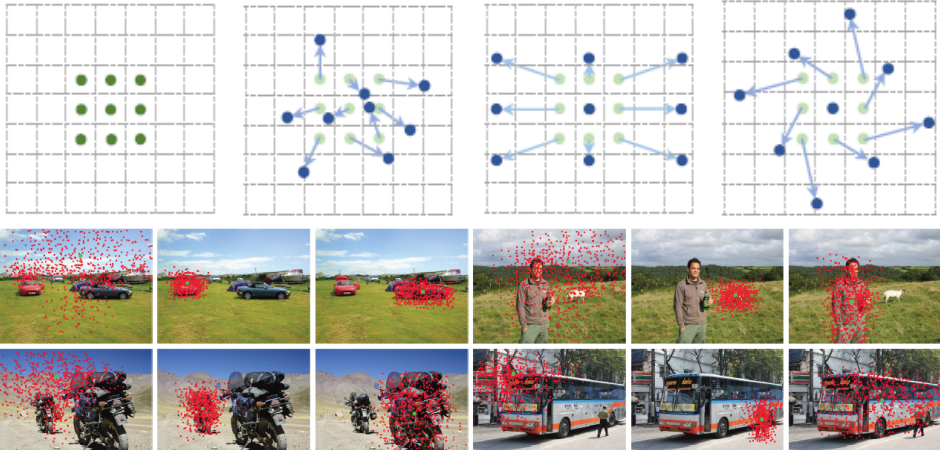



1. In the second stage, each linear activation is run through a nonlinear activation function, such as the rectified linear activation function. This stage is sometimes called the detector stage.



1. CNNs also incorporate pooling layers, where an operation is applied to all elements within the filtering extent. This corresponds, effectively, to downsampling.
2. The pooling filter has width and height and is applied with a given stride. It is most common to use the $\max()$ operation as the pooling operation.

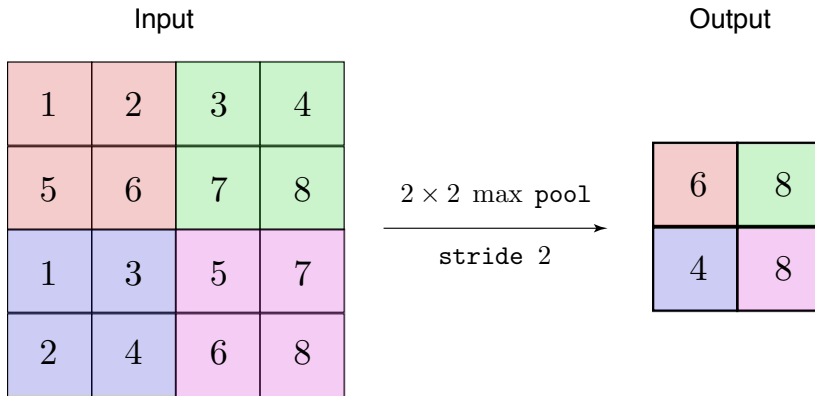



1. Invariance example:

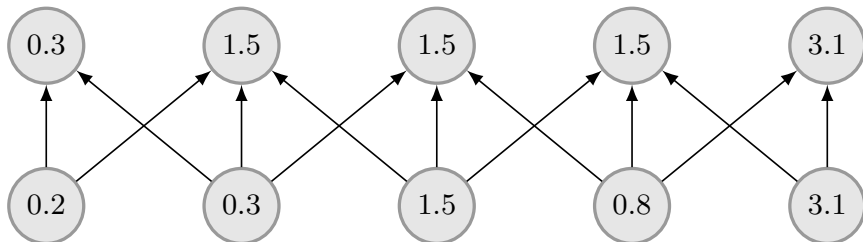

2. Inputs shifted by 1. Five inputs changed but only three outputs changed.

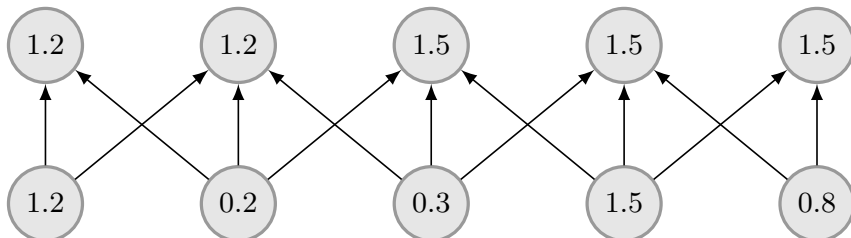



1. A weak prior is a prior distribution with high entropy, such a Gaussian distribution with high variance.
2. A strong prior has very low entropy, such as a Gaussian distribution with low variance.
3. An infinitely strong prior places zero probability on some parameters.
4. A convolutional net is similar to a fully connected net with an infinitely strong prior over its weights
5. The weights for one hidden unit must be identical to the weights of its neighbor, but shifted in space.
6. The use of pooling is in infinitely strong prior that each unit should be invariant to small translations.

1. Performance of CNNs degrade rapidly on tasks where images are of low resolution or objects are small.
2. Sunkara and Luo designed a CNN in which **strided convolution** and **pooling are not used** (Sunkara and Luo 2022).

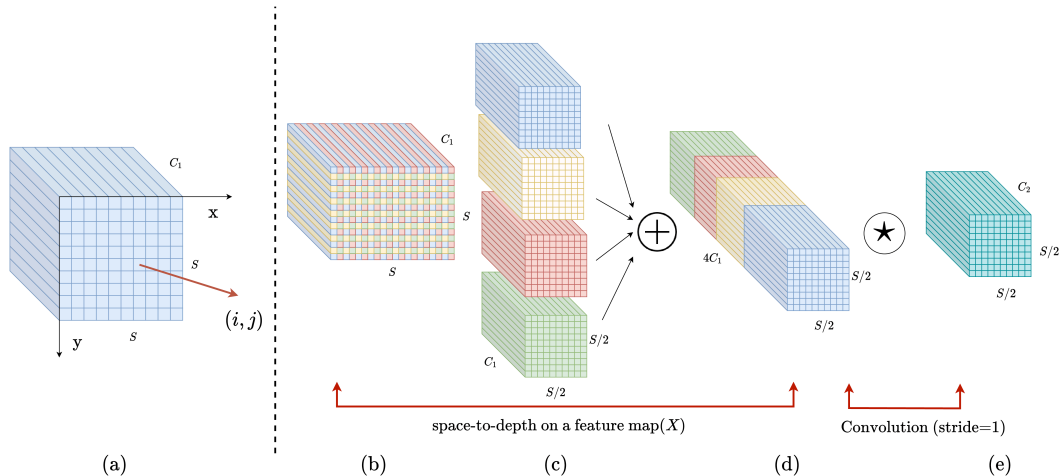

Convolutional neural network architectures



1. Typically, convolutional neural networks are comprised of units that are composed of:
 - ▶ Several paired convolutional-relu layers.
 - ▶ Potentially one max pooling layer.
2. These units are cascaded. Finally, a CNN may end with a fully connected-relu layer, followed by a softmax classifier.

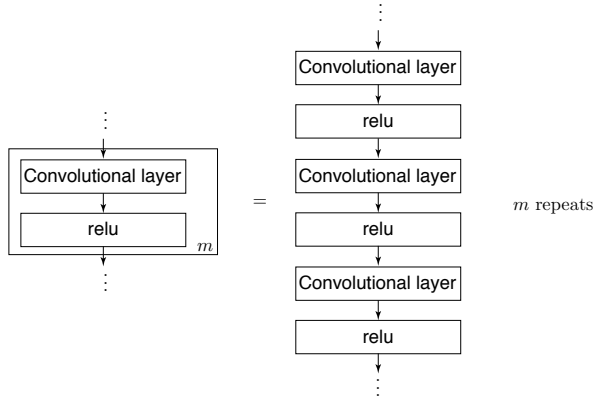



1. The following describes a fairly typical CNN architecture.

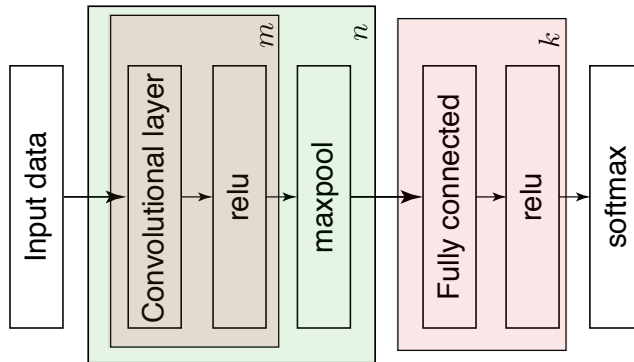

Case studies



1. Beyond this, there are many architectural considerations (as measured by ImageNet performance).
 - ▶ LeNet-5 (LeCun et al. [1998](#))
 - ▶ AlexNet (Krizhevsky, Sutskever, and Hinton [2012](#)) and ZFNet (Zeiler and Fergus [2014](#))
 - ▶ VGGNet and small filters (Simonyan and Zisserman [2015](#))
 - ▶ GoogLeNet and inception layers (Szegedy et al. [2015](#))
 - ▶ ResNet and residual layers (He et al. [2016](#))
 - ▶ FractalNet and the importance of reducing effective depth (Larsson, Maire, and Shakhnarovich [2017](#))

- ▶ LeNet-5 is a convolutional network designed for handwritten and machine-printed character recognition (LeCun et al. 1998).
- ▶ It has 2 convolutional layers (with sigmoid activation function) and 3 fully-connected layers (with sigmoid activation function) (hence “5”).
- ▶ The average-pooling layer was used as a sub-sampling layer.
- ▶ ReLUs and max-pooling work better.
- ▶ This architecture has about 60,000 parameters.
- ▶ Demo : <http://yann.lecun.com/exdb/lenet/>

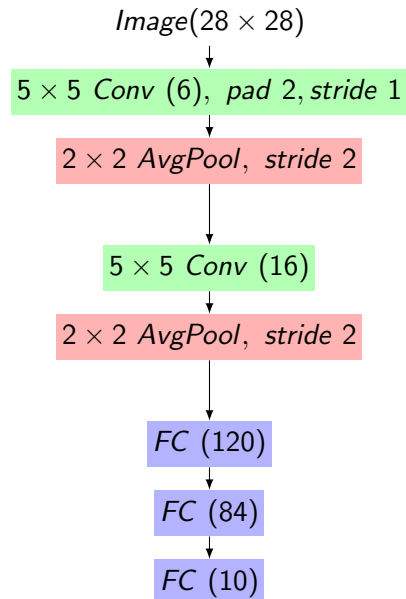

1. AlexNet has been proposed for image classification (Krizhevsky, Sutskever, and Hinton 2012).

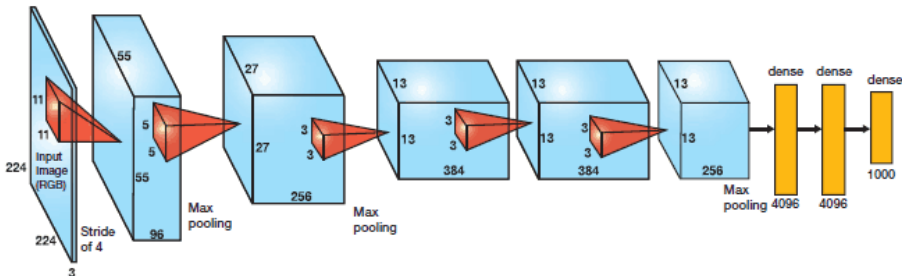

2. Dropout is used in the last few fully-connected layers to randomly ignore some neurons during training to avoid overfitting.
3. First layer (CONV1): 96 11×11 filters applied at stride 4
4. MaxPool (MaxPool1) 3×3 filters applied at stride 2. Max pooling can avoid the blurred result of average pooling.
5. Local response normalization is used.
6. Two GPUs are used to train AlexNet.

1. AlexNet architecture is [CONV1-MaxPOOL1-Norm1-CONV2-MaxPOOL2-Norm2-CONV3- CONV4-CONV5-MaxPOOL3-FC6-FC7-FC8].

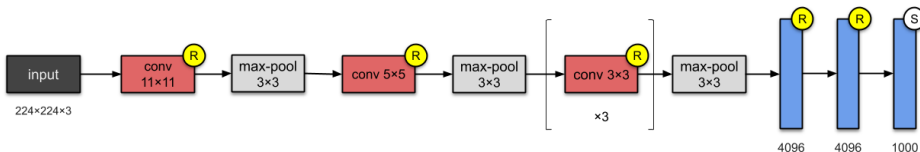

2. AlexNet has 8 layers — 5 convolutional and 3 fully-connected..
3. AlexNet has 60M parameters.
4. They were the first to implement Rectified Linear Units (ReLUs) as activation functions.

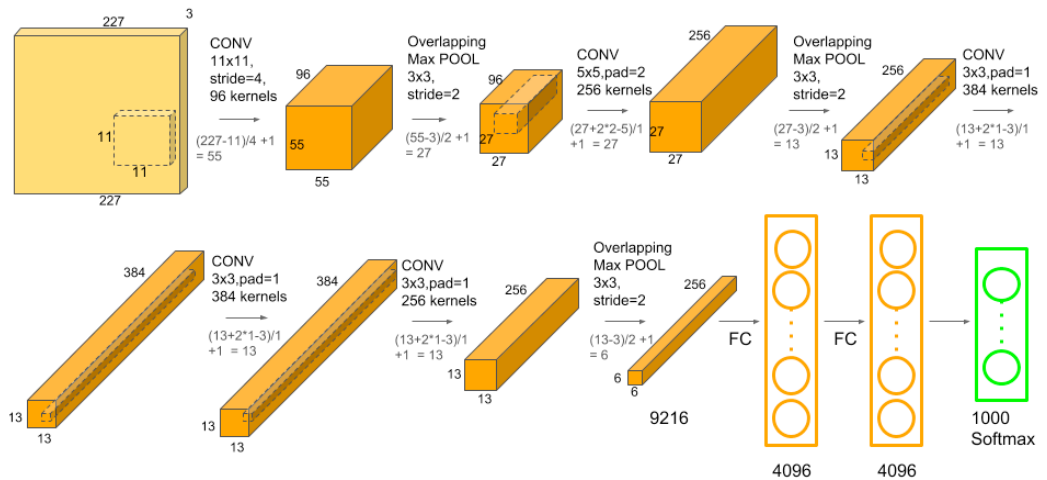



227x227x3 INPUT

55x55x96 CONV1: 96 11x11 filters at stride 4, pad 0

27x27x96 MAX POOL1: 3x3 filters at stride 2

27x27x96 NORM1: Normalization layer

27x27x256 CONV2: 256 5x5 filters at stride 1, pad 2

13x13x256 MAX POOL2: 3x3 filters at stride 2

13x13x256 NORM2: Normalization layer

13x13x384 CONV3: 384 3x3 filters at stride 1, pad 1

13x13x384 CONV4: 384 3x3 filters at stride 1, pad 1

13x13x256 CONV5: 256 3x3 filters at stride 1, pad 1

6x6x256 MAX POOL3: 3x3 filters at stride 2

4096 FC6: 4096 neurons

4096 FC7: 4096 neurons

1000 FC8: 1000 neurons (class scores)

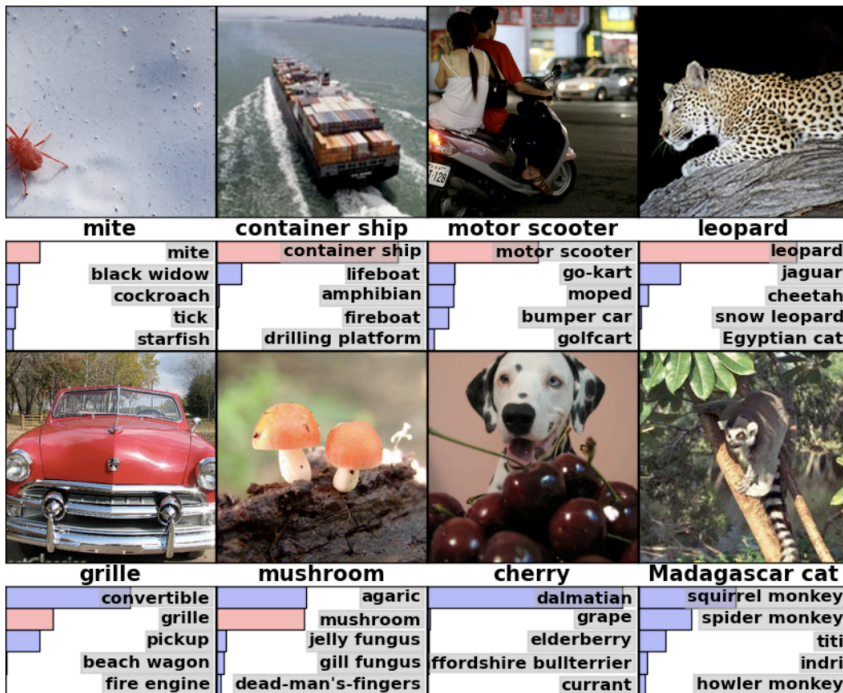

1. ZFNet has the following architecture (Zeiler and Fergus 2014).

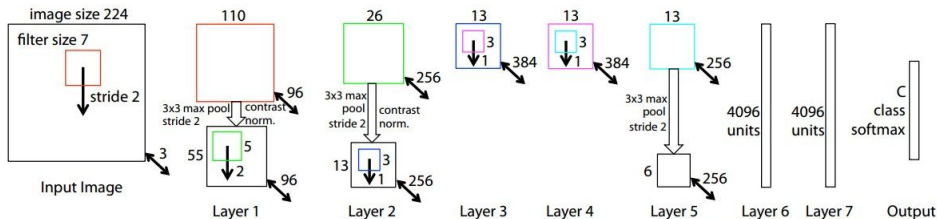

2. ZFNet is AlexNet with the following modifications
3. CONV1: change from (11x11 stride 4) to (7x7 stride 2)
4. CONV3,4,5: instead of 384, 384, 256 filters use 512, 1024, 512



1. VGGNets are a series of convolutional neural network algorithms proposed by the Visual Geometry Group (VGG) of Oxford University, including VGG-11, VGG-11-LRN, VGG-13, VGG-16, and VGG-19.
2. VGGNets secured the first place in the localization track of ImageNet Challenge 2014.
3. The LRN ([Local Response Normalization](#)) layer was removed since the author of VGGNets found the effect of LRN in deep CNNs was not obvious.
4. VGGNets use 3×3 convolution kernels.
5. VGGNet uses [small filters](#), [deeper networks](#)
6. VGGNet has the following architecture (Simonyan and Zisserman [2015](#)).
 - ▶ Only 3×3 CONV with stride 1,
 - ▶ Pad 1
 - ▶ 2×2 MAX POOL with stride 2



VGG16

VGG19

1. The VGG-16 which has 13 convolutional and 3 fully-connected layers with ReLU activation function.

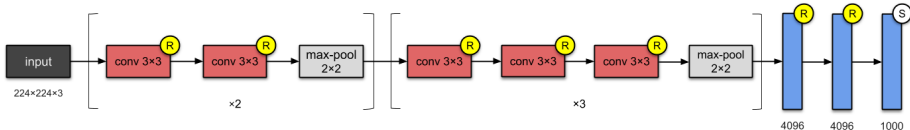

2. This network stacks more layers onto AlexNet.
3. It uses smaller size filters (2×2 and 3×3). It consists of 138M parameters.
4. The contribution from this paper is the designing of deeper networks (roughly twice as deep as AlexNet).



1. GoogLeNet is the winner of the ILSVRC 2014 image classification algorithms (Szegedy et al. [2015](#)).
2. It is the first large-scale CNN formed by stacking with [Inception modules](#).
3. GoogLeNet didn't use fully connected layers and [global average pooling](#) is used at the end of the network and eliminating a large amount of parameters that do not seem to matter much.
4. This layer takes a feature map of 7×7 and averages it to 1×1 .
5. This 22-layer architecture with 5M parameters is called the Inception-v1.
6. Its main contribution was the development of an Inception Module that dramatically reduced the number of parameters in the network (4M, compared to AlexNet with 60M).
7. It achieved a top-5 error rate of 6.67%!



1. Objects in images have different distances to cameras and then have large variation in size.
2. An object with a large (**small**) proportion of an image usually prefers a large (**small**) convolution kernel or a few small (**many large**) ones.
3. Hence, choosing the right kernel size becomes a challenging problem.
4. A **larger/smaller kernel** is useful for globally/locally distributed information.
5. Very deep networks may overfit and stacking large convolution layers is computationally expensive.
6. GoogleNet use filters with multiple sizes operating on the same level. Hence the network becomes wider.
7. Inception modules are used to implement filters with multiple sizes operating on the same level.
8. Inception modules have four versions, namely Inception v1, Inception v2, Inception v3, and Inception v4.

1. GoogLeNet has the following architecture.

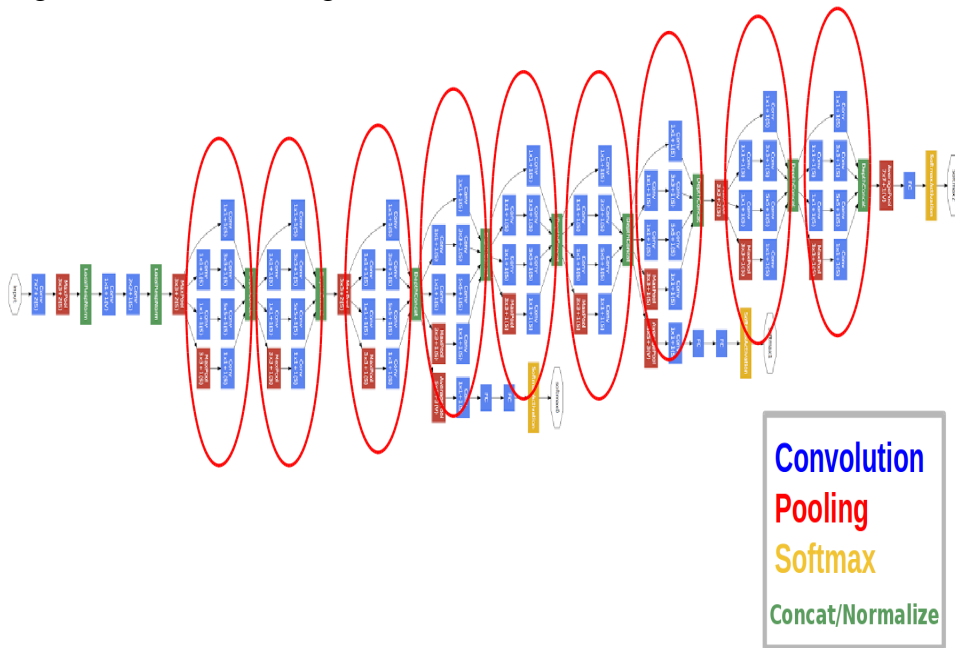

1. Inception V1 module has the following architecture.

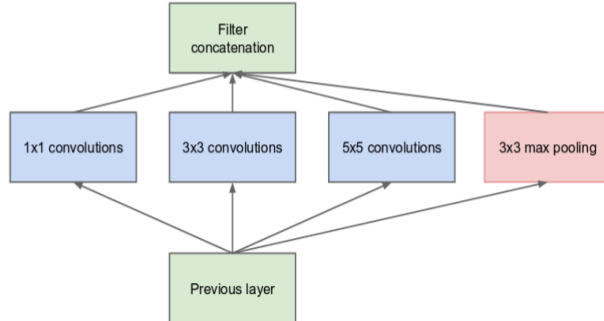

2. Inception V1 performs convolution on an input, with 3 different sizes of filters: 1×1 , 3×3 , and 5×5 .
3. It also performs **max pooling**.
4. The outputs of these filters are concatenated and sent to the next inception module.



1. To reduce computational cost, inception module uses 1×1 convolution kernel to reduce the number of channels.
2. Consider a $28 \times 28 \times 190$ input and use 48 5×5 kernels resulting $28 \times 28 \times 48$ feature map.
3. Number of parameters: $(5 \times 5 \times 190) \times (28 \times 28 \times 48) = 178,752,000$.
4. Now first use 16 1×1 kernels and then use 48 5×5 resulting $28 \times 28 \times 48$.
 - ▶ Number of parameters in first layer: $(5 \times 5 \times 190) \times (28 \times 28 \times 16) = 118,750$.
 - ▶ Number of parameters in second layer: $(5 \times 5 \times 16) \times (28 \times 28 \times 48) = 15,052,800$.
 - ▶ The total number of parameters: $118,750 + 15,052,800 = 15,171,550$.

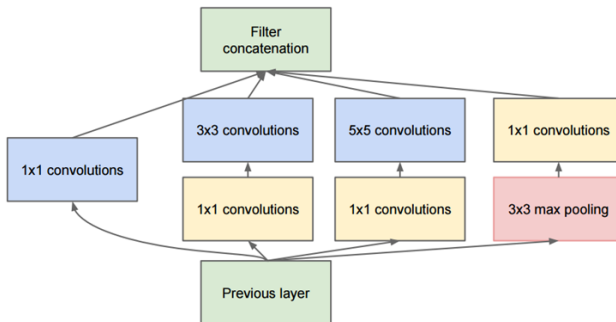

1. Inception V2 uses batch normalization layer.
2. Inception V1 5×5 filter aggressively decreases the feature map.
3. Inception V2 replaces 5×5 filter by two 3×3 filters.

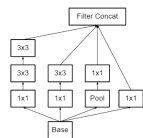

1. Inception V2 also uses asymmetric convolution.
2. Each 3×3 filter factorized by 1×3 and 3×1 filters.

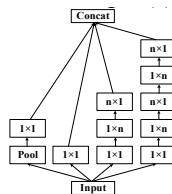

1. The use of factorization is not effective in the early layers.
2. It is better to use it on medium-sized feature maps.
3. Filter banks should be expanded (wider but not deeper) to improve high dimensional representations.

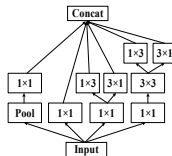

1. ResNet is a new 152 layer network architecture (He et al. 2016).
2. ResNet has the following architecture.

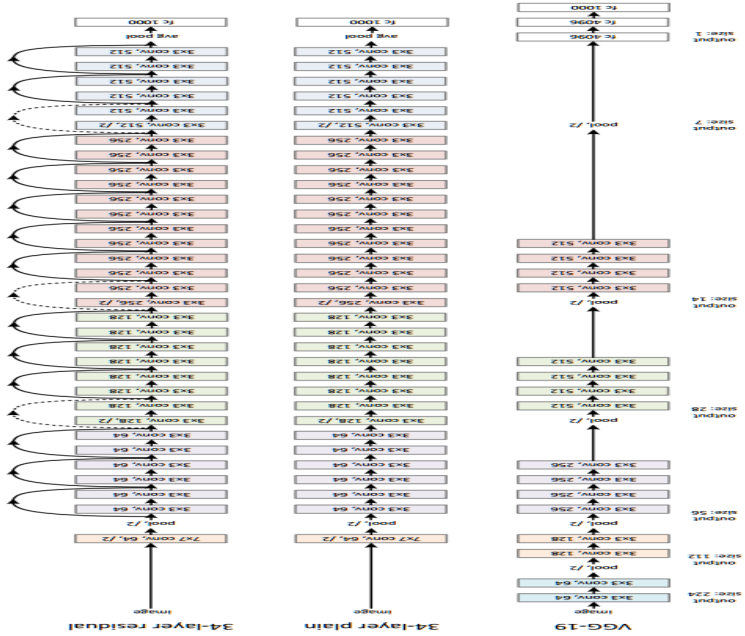

1. ResNet has stacked residual blocks.
2. Every residual block has two 3x3 conv layers

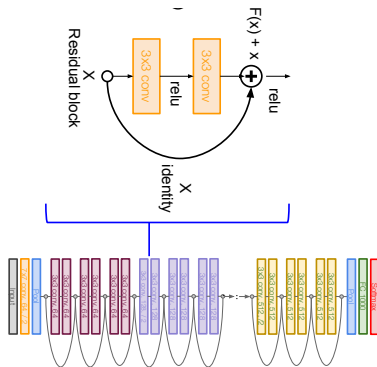

3. The authors believe that “it is easier to optimize the residual mapping than to optimize the original, unreferenced mapping”.
4. The ResidualNet creators proved empirically that it’s easier to train a 34-layer residual compared to a 34-layer cascaded (Like VGG).

1. Google proposed MobileNet V1 to reduce the model size and complexity(Howard et al. 2017).
2. Depthwise Separable Convolution is used.
3. It is useful for mobile and embedded vision applications

In a standard convolution, we would directly convolve in depth dimension.

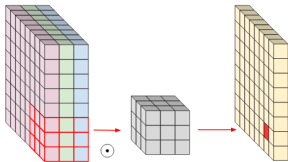

In depthwise convolution, each filter channel only used at one input channel.

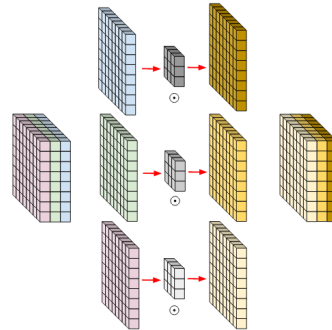

Depthwise separable convolution uses 1×1 convolution after Depthwise convolution².

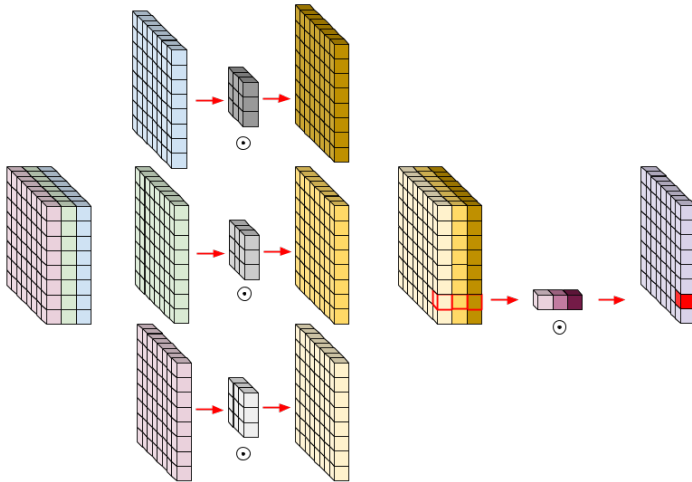

²Figure taken from Atul Pandey page



ImageNet is an image database organized according to the WordNet hierarchy.

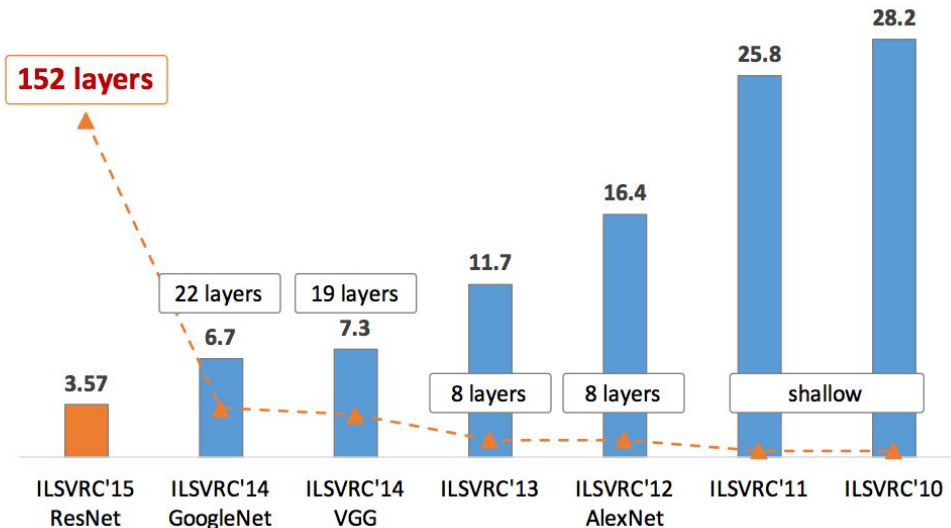



1. Inception-v3 (2015)
2. Xception (2016)
3. Inception-v4 (2016)
4. Inception-ResNet-V2 (2016)
5. ResNeXt-50 (2017)
6. DenseNet (CVPR 2017)
7. MobileNets (2017 & 2018)
8. For more networks, please study the networks given in
<https://paperswithcode.com/sota/image-classification-on-imagenet>







Reading









1. Chapter 9 of [Deep Learning Book](#)³

³Ian Goodfellow, Yoshua Bengio, and Aaron Courville (2016). *Deep Learning*. The MIT Press.



-  Dai, Jifeng et al. (2017). “Deformable Convolutional Networks”. In: *IEEE International Conference on Computer Vision*, pp. 764–773.
-  Goodfellow, Ian, Yoshua Bengio, and Aaron Courville (2016). *Deep Learning*. The MIT Press.
-  He, K. et al. (2016). “Deep Residual Learning for Image Recognition”. In: *Proc. of the IEEE Conference on Computer Vision and Pattern Recognition (CVPR)*, pp. 770–778.
-  Howard, Andrew G. et al. (2017). *MobileNets: Efficient Convolutional Neural Networks for Mobile Vision Applications*. eprint: [1704.04861](https://arxiv.org/abs/1704.04861).
-  Krizhevsky, Alex, Ilya Sutskever, and Geoffrey E. Hinton (2012). “Imagenet classification with deep convolutional neural networks”. In: *Advances in neural information processing systems*, pp. 1097–1105.
-  Larsson, Gustav, Michael Maire, and Gregory Shakhnarovich (2017). “FractalNet: Ultra-Deep Neural Networks without Residuals”. In: *International Conference on Learning Representations*.



-  LeCun, Yann et al. (1998). “Gradient-Based Learning Applied to Document Recognition”. In: *Proceedings of the IEEE*. Vol. 86. 11, pp. 2278–2324.
-  Li, Zewen et al. (2020). “A Survey of Convolutional Neural Networks: Analysis, Applications, and Prospects”. In: *CoRR* abs/2004.02806.
-  Simonyan, Karen and Andrew Zisserman (2015). “Very Deep Convolutional Networks for Large-Scale Image Recognition.”. In: *International Conference on Learning Representations*.
-  Sunkara, Raja and Tie Luo (2022). “No More Strided Convolutions or Pooling: A New CNN Building Block for Low-Resolution Images and Small Objects”. In: *Proc. of European Conference on Machine Learning and Principles and Practice of Knowledge Discovery in Databases*.
-  Szegedy, Christian et al. (2015). “Going Deeper with Convolutions”. In: *Computer Vision and Pattern Recognition (CVPR)*.
-  Zeiler, Matthew D. and Rob Fergus (2014). “Visualizing and Understanding Convolutional Networks”. In: *Proc. of European Conference on Computer Vision*, pp. 818–833.

